

RELAP5 ANALYSES OF HEATED VACUUM DRYING SYSTEM PRESSURIZATION

Chang H. Oh, Cliff Davis, Jim Fisher, Dick Schultz, and Mike Edgett
Idaho National Engineering and Environmental Laboratory
Idaho Falls, Idaho 83415

Email: chh@inel.gov, cbd@inel.gov, jef@inel.gov, srr@inel.gov, sme@inel.gov

ABSTRACT

This paper documents RELAP5 results of the Heated Vacuum Drying System (HVDS) response to overpressurization of TMI canisters. RELAP5 was used to calculate transient pressures when hypothetical overpressurization events are considered. RELAP5 results indicate that the steam flow is friction limited and that a pressure relieve valve adequately relieves the pressure for scenarios involving overpressure in four canisters if the valve functions.

INTRODUCTION

The Heated Vacuum Drying System (HVDS), located at the Test Area North (TAN) Hot Shop at the Idaho National Engineering and Environmental Laboratory (INEEL), is presently being used to process the TMI-2 fuel canisters to preclude criticality concerns during transportation and storage of the canisters. Analyses were conducted to calculate the transient pressure history when the overpressurization events are considered in the system. The details of these analyses using RELAP5 (Ref. 1.-version 2000-ci) are contained in this paper.

SCENARIO DESCRIPTION

This scenario assumes normal vacuum furnace operation, at initial furnace pressure of 10 torr (0.19 psia). It is assumed that spontaneous nucleation or other mechanism pressurizes one or all four TMI canisters to 60 psid (pressure differential), at which point a canister rupture disk ruptures. The path is via the 1/8-inch orifice attached to the filter. In this scenario, the liquid water initially contained in the Licon (light concrete) was assumed to be dumped to the canister due to breakup of the Licon. The following assumptions were made:

1. Pressure is initially 10 torr in the canister, furnace, and pores - temperature is 80°F.
2. The filters clog, thereby isolating the canister from the furnace.

3. Liquid water is initially present in the Licon. It is postulated that the pores of the Licon have become plugged, thereby causing the water to become trapped.
4. Heating of the canister begins. Because the pores are filled with nearly incompressible liquid, the pressure in the pores rapidly increases. The pressure at which the Licon fractures is 237 psia (Ref. 2). The Licon cracks allowing the water to escape into the canister.
5. Heating of the canister continues until it is pressurized to 60 psia (Ref. 3) at which point the canister rupture disk is assumed to be ruptured.
6. Because this scenario incorporates spontaneous nucleation, the pores are treated as a water source with heat (14 kW/canister, (Ref 4)) applied.
7. The initial liquid water is assumed to be saturated liquid in the Licon (80°F, $x(\text{quality}) = 0.$, 8.4% porosity, (Ref. 5)). The corresponding mass of liquid water is 23 lbs each.
8. The calculation assumes no liquid accumulation (no back pressure) in the collection tank (55 gallon drum).

Spontaneous Nucleation and Maximum Steam Release Rate from the Fuel Canister

Postulated Mechanism for water entrapment within the Licon

Spontaneous nucleation is one of the phenomenon postulated to occur within the Licon. The Licon block is made of concrete cement with different compositions of aluminum, silicate compounds, calcium and others. When calcium ions in water or calcium ions in the Licon are reacted with silicon or its compounds in the Licon, they produce $\text{CaOMgO}_2\text{SiO}_2$, and CaSiO_3 that are insoluble in water. It is postulated that these compounds eventually block the pores of the Licon porous media. If this scenario occurs, the water is retained inside the Licon during the vacuum evaporation until the thermal energy results in pressure sufficient to fracture the Licon or until some other mechanism reopens the pores.

The Licon will fracture when the internal pressure exceeds the tensile strength of the Licon. The tensile strength can be calculated as follows:

$$S_t = 7.5\sqrt{f_c'} = 237 \text{ psi (Ref. 2)}$$

$f_c' = 1000 \text{ psi (Ref. 6)}$ where f_c' is the design compression strength of the Licon.

$$S_t = 237 \text{ psia}$$

When this pressure is exceeded, the Licon will fracture and the water will be released into the canister. Because the canister is heated, the pressure will continue to increase until the rupture disk is ruptured. At this point, steam will be vented directly to the furnace.

Pressurization and Maximum Critical Steam Flow

From the aforementioned scenario, the critical steam flow rates were calculated based upon the state of the furnace at the rupture disk operation point.

Assumptions made for these calculations are listed below:

1. The canister rupture disk is ruptured at 60 psid. The rupture disk flow area is assumed to be the full flow area (1/8-inch diameter or both 1/8-inch and 1/4-inch diameters) with a discharge coefficient of 1 to allow fluid discharge into the furnace cavity at maximum flow rates (a conservative assumption).
2. The HDVC is operated at 10 torr (0.19 psia) when the steam is released.
3. Ideal gas law applies.
4. When the steam is released, the furnace environment is assumed to be saturated.
5. The fluid in the canister undergoes isothermal expansion.
6. Homogeneous equilibrium model was used to calculate critical flow.
7. The final furnace volume does not include the canister volume, which is a conservative assumption because it gives a larger pressure.
8. The PRV flow area and discharge coefficient, based on calibration data recorded on site (Ref. 3) is based on a 1/2-inch diameter orifice with a discharge coefficient of 1.
9. The calculation assumes no liquid accumulation (no back pressure) in the collection tank (55 gallon drum).
10. The calculation assumes no steam condensation will occur in the furnace discharge line with accompanying two-phase flow, collection of condensate in line low points as the depressurization rate is reduced, and collection of condensate in the collection tank.

Case 1. One canister rupture disk ruptures (1/8 inch) when canister is initially empty of liquid (except that trapped in Licon pores).

Ideal gas law equation:

$$P = \frac{P' \cdot V'}{V}$$

where P = furnace pressure, P' = canister pressure, V' = canister volume (net canister volume + pore volume in Licon), and V = furnace volume (furnace free volume - volumes occupied by 4 canisters). The pore volume occupied by water in Licon was calculated as below:

$$4.3918 \text{ ft}^3 (\text{total Licon volume, (Ref.4)}) \times 0.084 (\text{void of Licon, (Ref.5)}) = 0.37 \text{ ft}^3$$

The initial furnace pressure is at 10 torr (0.19 psia). In order to rupture the disk, the canister pressure should be at least 60.19 psia. This pressure will be dumped to the 0.19 psia in the furnace. Therefore, the final furnace pressure will be:

$$P = (60. + 0.19) \text{ psi} * (6.75 \text{ ft}^3 (\text{canister vol. (Ref. 7)}) + 0.37 \text{ ft}^3 \text{ pore volume}) / (136.25 \text{ ft}^3 (\text{Ref. 7}) - 13.36 \text{ ft}^3/\text{canister (Ref. 7)} * 4 \text{ canisters}) = 5.18 \text{ psia (0.0357 MPa, Tsat} = 164^{\circ}\text{F}).$$

For this calculation, the free volume in each canister is not included to be conservative.

Using $P=0.0357 \text{ MPa}$ as the upstream pressure, a maximum equilibrium steam flow of 59.3 lbs/hr through the PRV-3 valve (1/2-inch orifice) was obtained from RELAP5 steam table (Ref. 8).

Case 2. Four canisters rupture disks rupture (1/8 inch each) when canisters are initially empty of liquid (except that trapped in Licon pores).

Similarly, using $P = 60.19 \text{ psi} * 7.12 \text{ ft}^3/\text{canister} * 4 \text{ canisters} / (136.25 - 13.36 \text{ ft}^3/\text{canister} * 4 \text{ canisters}) = 20.7 \text{ psia (0.1427 MPa, Tsat} = 230^{\circ}\text{F})$ and $x=1.0$, a maximum equilibrium steam flow of 218.5 lbs/hr through the PRV-3 valve (1/2 inch orifice) was obtained from RELAP5 steam table.

The purpose of these hand calculations is to determine whether maximum equilibrium steam flow rate exceeds the rated flow of the relief valve. The furnace pressure is used as input for maximum critical flow calculations. The design furnace pressure is reported to be 14.7 psig (27.1 psia at the site elevation) (Ref. 3).

From the above it is concluded that following dewatering of canisters, enough water remains (even in Licon) to increase canister pressure sufficient to rupture the rupture disk.

RELAP5 MODEL AND RESULTS

RELAP5 model was developed including all the components involved in the HDVC vacuum system as shown in Figure 1.

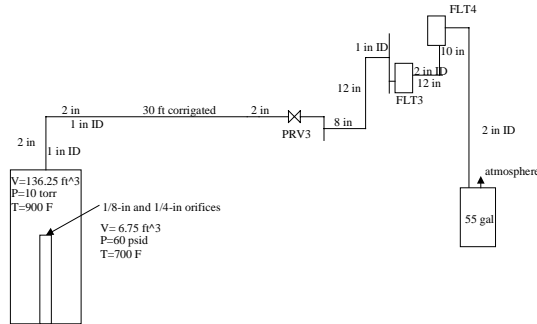

Figure 1. Schematic Diagram of HDVC.

Figure 1. Schematic of HVDC system.

Assumptions:

1. The canister rupture disk is ruptured at 60 psid (all Cases).
2. The canister rupture disk is ruptured through a 1/8-in (Cases 1,2, 3 and 5) or both 1/8-in and 1/4-in orifices (only 6).
3. At the rupture point, the furnace pressure and temperature are 10 torr and 900⁰F.
4. Friction factor of the 30 ft corrugated line is 0.0463 by the Moody's chart based on the 40 gal /min. water flow rate at a pressure drop of 1 psi per ft (Ref 6) .
5. Pressure drops on FLT-3 and FLT-4 are 2 psid and 5 psid, respectively at 300 scfm (air) (Ref. 6).
6. PRV-3 pressure is set at 5 psig (17.4 psia at our elevation).

Other inputs to RELAP5 Model:

1. calculation of the final state of the canister:
Licon pore void fraction = 8.4% (Ref. 5)
Volume of pore occupied by water in the Licon = 4.3918 (Ref. 4) x 0.084 = 0.37 ft³
Water (in the Licon at 80⁰F and x = 0) = 0.37 ft³ x 62.2 lb/ft³ = 23.014 lbs

Steam (in the canister at 80⁰F and x = 1) = 6.75 ft³ x 1.57e-3 lb/ft³ (from RELAP5 steam table) = 0.0107 lbs

$$M_t = 23.0247 \text{ lbs}$$

$$\text{Density} = M_t / (6.75 + 0.37) = 3.2338 \text{ lb/ft}^3$$

At P= 60 psia and density =3.2338 lb/ft³, α (void fraction) =0.94608 from RELAP5 steam table. All the liquid was placed in the lowest hydrodynamic volume (three hydrodynamic volumes) of the canister, which was divided into three volumes.

2. Heat Inputs

A heating value of 14 kW / canister (Ref. 4) was applied to the canister, which is coupled with the canister (single volume 100) shown in RELAP5 node diagram (Figure 2).

In RELAP5 model, the heater was tripped off shortly before the liquid water was all evaporated to prevent unrealistic heating of the steam.

All the friction associated with pipelines, valve, filters, and others (Ref. 10) are incorporated into RELAP5 model.

Figure 2 shows RELAP5 node diagram, which includes all the components in shown Figure 1.

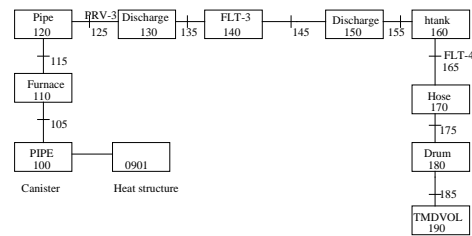

Figure 2. RELAP5 Node Diagram.

Figure 3 shows transient pressures when one 1/8 inch canister rupture disk is ruptured. As shown in this figure, the canister rupture disk ruptures at time = 0 and 60 psia as it is modeled. It increases up to 75 psia because the steam generated by the heating exceeds the relief capacity of the 1/8-inch orifice. The PRV-3 opens at around 300 seconds and maintains the furnace pressure less than 15 psia. The liquid in the canister is boiled away at about 1500 seconds and the power to the canister is stopped. The pressure in the canister then falls to that of the furnace.

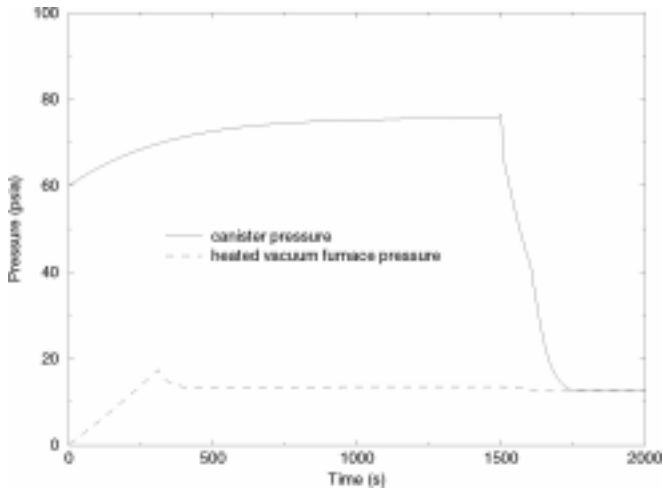

Figure 3. Transient pressure in the vacuum furnace and canister with one canister rupture disk ruptured.

Figure 4 shows results when four 1/8 inch canister rupture disks are ruptured to the furnace. The PRV-3 valve opens at 60 seconds and the furnace is pressurized up to 24 psia. The pressure drops at around 1500 seconds when the water is evaporated.

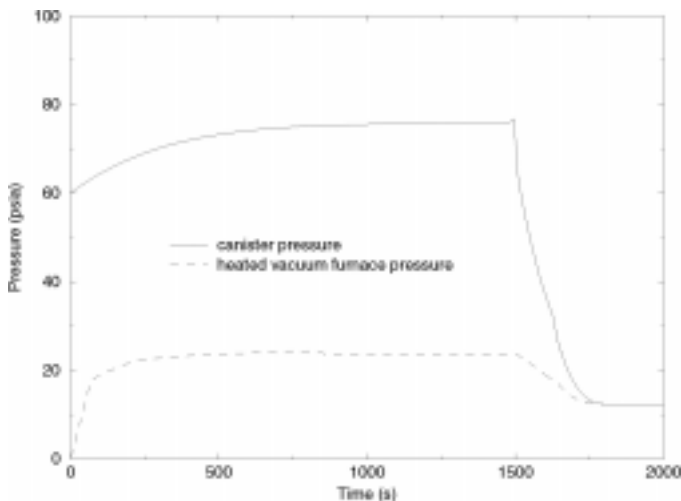

Figure 4. Transient pressure in the vacuum furnace and canister with four canister rupture disks ruptured.

Figure 5 shows transient mass flow through PRV-3 valve when four canister rupture disks rupture. The flow oscillations between around 750 seconds and 930 seconds are due to the interfacial phenomena between the small amount of liquid droplets and steam in the relief line. The mass flow is about 198 lbs./hr, which is less than 218.5 lbs/hr that PRV-3 will handle at these differential pressures.

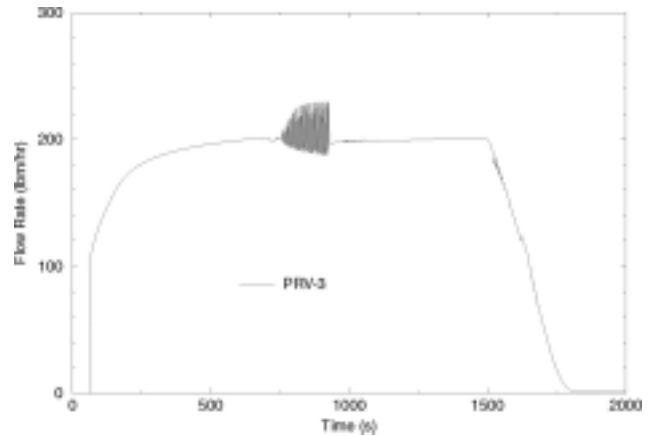

Figure 5. Transient mass flow through PRV-3 valve with four canisters rupture disks ruptured.

Case 3. Four canisters rupture disks rupture when four canisters are initially 50% full of liquid water. The furnace pressure is assumed to be 12.4 psia for a pressure sensitivity study.

In order to determine the sensitivity of transient furnace pressure to the initial furnace pressure and the initial mass of liquid in the canister (see Case 2, Figure 4 and 5), RELAP5 runs were made with initial furnace pressure set to 12.4 psia. The results are shown in Figure 6.

Figure 6 shows transient pressure in the furnace with four 1/8 inch canister rupture disks ruptured with an initial atmospheric pressure of the furnace. As shown in Figure 6, the furnace pressure is insensitive to the initial pressure. It starts at 12.4 psia, reaches a peak pressure of 24 psia, and then drops to 12.4 psia.

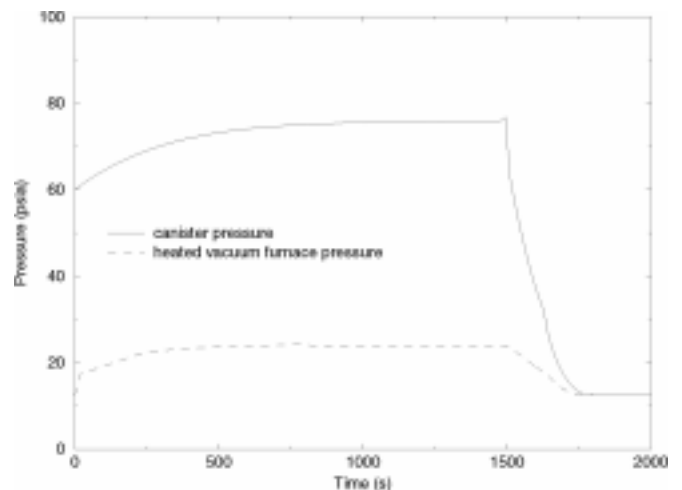

Figure 6. Transient pressure in the furnace and four canister rupture disks ruptured with an initial atmospheric pressure of the furnace.

Figure 7 shows transient pressures with four canisters half full of liquid as the initial condition. As shown in Figure 7, when the relief valve opens, the furnace pressure remains at 24 psia and it will drop when the liquid is completely evaporated as shown in Figure 4.

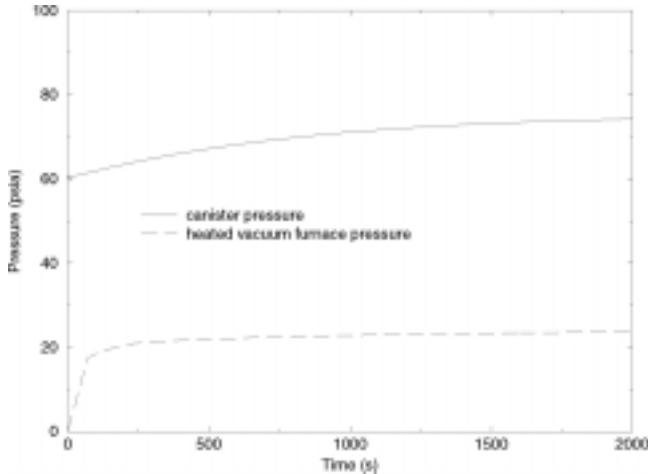

Figure 7. Transient pressure with four canisters half full of liquid.

Case 4: Four canisters are 100% filled with liquid water. In this case, PRV-3 does not open, no other fluid flows through the vacuum line (sealed vacuum furnace), and heat is applied onto four canisters.

Hand calculations were made for Case 4 as follows:

Step 1 - determine density at 80 torr and $x = 0$ (saturated liquid): 61.8 lbs/ft³

Step 2 - calculate the density of water when all liquid is dumped to the furnace without the relief valve open:

$$\rho = \frac{4 \times 7.12 \text{ft}^3 \times 61.8 \text{lb/ft}^3}{136.25 \text{ft}^3 - 4 \times 13.36} = 21.25 \text{lb/ft}^3$$

Step 3 - obtain the furnace pressure at 900°F and the density calculated from step 2:

$P = 8061$ psia (from RELAP5 steam table).

Similarly, $P = 6227$ psia (Knockout canister) and $P = 3784$ psia (Debris canister).

Case 5: Four canisters are 100% filled with liquid water. PRV-3 opens appropriately at 5 psig. No other fluid flows through the vacuum line and heat is applied onto four canisters. The liquid water is ruptured through only 1/8-in orifice to see the transient pressure of the canisters and the furnace.

RELAP 5 model was revised to compute the pressure of the furnace assuming four canisters are 100% filled with

saturated water and the PRV-3, the relief valve, opens appropriately at 5 psig. In this calculation, the initial condition of the water in four canisters is saturated liquid at 80 torr. This condition was considered because we want to include the dynamic behavior of water when it boils off.

Figure 8 shows transient pressure of the furnace and canister. As shown in Figure 8, at about 4400 seconds, PRV-3 opens. The furnace pressure remains at 24.5 psia while the canister is pressurized at 76.5 psia.

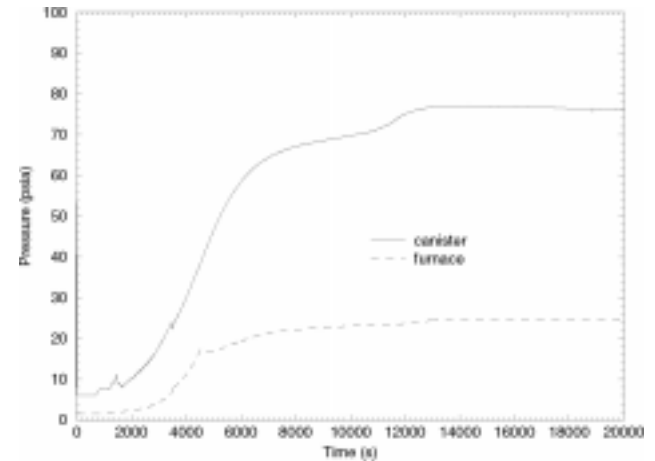

Figure 8. Transient pressure with four canisters 100% full of liquid (1/8-in orifice open).

Figure 9 shows the total mass flow through the PRV-3 valve. The mass flow rate is 205 lbs/hr that is slightly higher than the case with four canisters half filled with saturated steam.

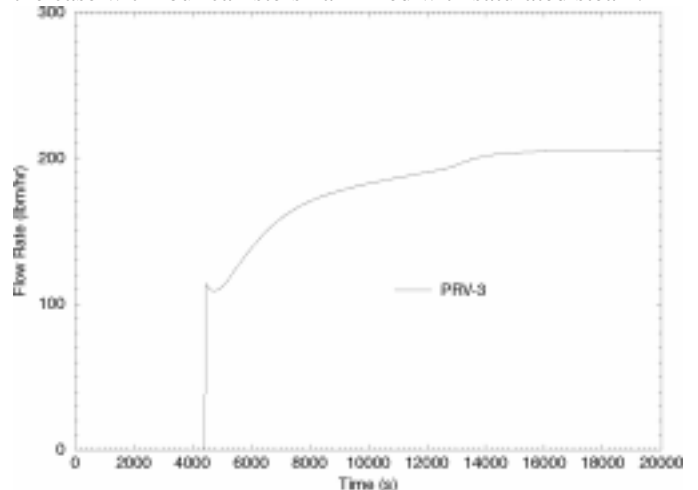

Figure 9. Transient mass flow through PRV-3 valve with four canister (full of water) rupture disks ruptured (1/8-in orifice open).

Case 6: The same as that of Case 5, but liquid water is ruptured through both 1/8-in and 1/4-in orifices to the furnace.

RELAP 5 model used for the Case 5 was revised with a change of four cross sectional areas of 1/8-in orifice ($3.401e-4 \text{ ft}^2$) to both orifices of 1/8-in and 1/4-in ($1.7e-3 \text{ ft}^2$).

Figures 10 and 11 show the transient pressure and the mass flow through the PRV-3, the relief valve. As shown in Figure 10, the PRV-3 opens at about 3000 seconds, which is earlier than that of Case 5, and the canister pressure is lower 30 psia because of steam release through a larger cross sectional area. The furnace pressure of 24.5 psia is close to 24 psia of Case 5 while the mass flow rate is 203 lbs/hr. These results indicate that once the PRV-3 valve relieves steam at 17 psia, the equilibrium steam flow is maintained at about 203 to 205 lbs/hr, which is lower than the maximum steam critical flow of 218.5 lbs/hr shown in Case 2.

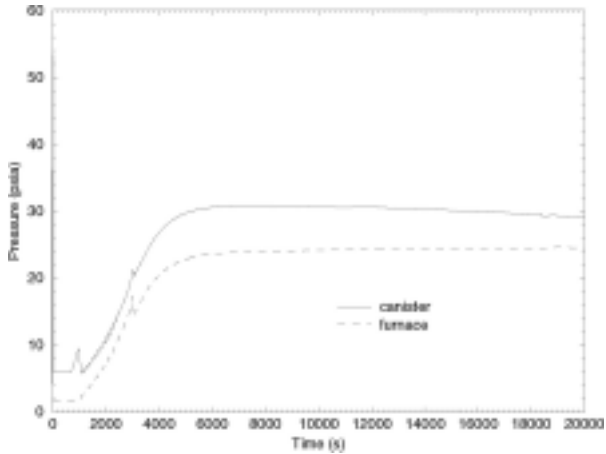

Figure 10. Transient pressure with four canisters 100% full of liquid (both 1/8-in and 1/4-in orifices open).

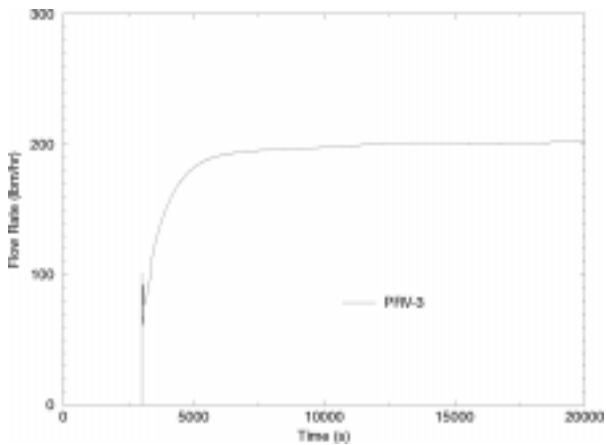

Figure 11. Transient mass flow through PRV-3 valve with four canister (full of water) rupture disks ruptured (both 1/8-in and 1/4-in orifices open).

CONCLUSIONS

The calculations performed during this scoping study show the furnace pressure does not exceed its design limit if PRV-3 and other discharge line components function as designed. However, the current discharge holding tank is unsuitable for the capture of steam released from half or fully-flooded TMI canisters, and may be inadequate for the containment of steam released in accident scenarios involving even de-watered canisters. It is highly recommended that a suitable sparging capability be designed and implemented on the HVDS to accommodate steam releases from postulated accident scenarios without contamination of Hot Shop air and equipment. Required size of such a sparging tank would be greatly reduced if only de-watered canisters were to be allowed in the HVDS drying cycle.

Detailed results are summarized below:

1. If the PRV-3 functions as designed, the furnace pressure stays below the design furnace pressure of 27 psia (plus 3 psia allowed by ASME Section VIII, Ref. 12) even when canisters are initially full of liquid water.
2. With four canister's rupture disks (half full or 100% full) ruptured, the equilibrium steam mass flow through the PRV-3 is 198 lbs./hr, and 205 lbs./hr which are less than the critical mass flow of 218.5 lbs./hr at that condition.
3. Without a properly functioning PRV-3 valve, the furnace pressure will exceed the design pressure if the canisters contain more than 0.08 gallons of water.
4. The current configuration of HVDS discharge holding tank (i.e., a 55-gallon drum) is unsuitable for the capture of steam released in overpressurization scenarios involving half- or fully-flooded TMI canisters, and may be inadequate for the containment of steam released in accidents involving even de-watered canisters. As observed in several analyzed scenarios, flooded canisters could produce steam equivalent to several times a 55-gallon volume of condensed water. It is also understood that some accumulation of liquid in the holding drum has been observed in past HVDS operations, and, depending on initial volume in the drum it is possible that even de-watered canisters might release enough moisture to cause an overflow if an overpressurization scenario were to occur.

ACKNOWLEDGEMENTS

This work was performed under the auspices of the U.S. Department of Energy under the DOE Operations Office Contract No. DE-AC0799ID13727.

REFERENCES

1. RELAP5/MOD3 Code Manual, Vol. 1-4, INEL, Idaho, NUREG/CR-5535, INEL-95/0174, 1995 (Also available on www.nrc.gov/RES/RELAP5/index.html).
2. P.M. Ferguson, *Reinforced Concrete Fundamentals*, 3rd Ed., John & Wiley, 1973.
3. Test Area North Operation Safety Analysis Report, INEL- 94/-063 Addendum 1, Revision ID:1
4. R.G. Ambrosek letter to A.J. Palmer, AMB-06-98, Temperature and Vapor Generation Response for TMI-4 Fuel Storage Cans in Furnace, February 23, 1998.
5. Product data, Alcoa Calcium Aluminate Cement CA-25C, Revised January 1986.
6. Private Communication with Chris Balton at Exolon.
7. C.Seaquist, TMI-2 Fuel Dry Storage Heated Vacuum Dryness Criteria Optimization, EDF-1352, August 12, 1998.
8. RELAP5-3D Code manual Volume 1: Code Structure, System Models, and Solution Methods, INEEL-EXT-98-00835, INEEL, February 1999.
9. Private communication with Bobby Picker at TAN. Flow of Fluids Through Valves, Fittings, and Pipe, Crane Co., 1981.
10. ASME Section VIII, Division 2, Article R-1, General Requirement, 1998.